

**DD Dolby\* B-C Type Noise Reduction System with Recording/Playback Equalizer Amplifier**

**Description**

The CXA1878Q is a bipolar IC with a built-in Dolby B-C type noise reduction system (NR), Dolby S type select switch, recording/playback equalizer, electronic volume, and bias control circuit.

Use of this IC in combination with two CXA1417S/Q completes a Dolby B-C-S type NR stereo system.

**Features**

- Dolby B-C type NR
- Built-in filter required for recording/playback equalizer amplifiers
- Recording mute function  
(requiring only an external time constant circuit to implement soft mute)
- Fade in/out DC controllable
- NORM/CrO<sub>2</sub>/METAL tape mode switching function
- NORM/HIGH tape speed switching function
- DC controllable for recording level calibration  
(approximately ±6dB variable)
- DC controllable for high frequency equalizer amplifier gain (approximately ±4dB variable)
- Playback deck A/B select switch
- Recording volume control
- Bias control circuit
- Meter circuit

**Applications**

Recording/playback equalizer amplifier for stereo analog cassette decks  
(Applicable to ALPS ELECTRIC CO., LTD.  
HADKH55 series heads)

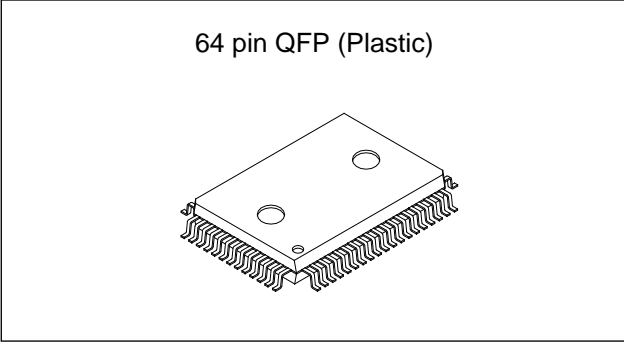

**Structure**

Bipolar silicon monolithic IC

**Absolute Maximum Ratings**

- Supply voltage V<sub>CC</sub> 17 V
- Operating temperature T<sub>opr</sub> -20 to +75 °C
- Storage temperature T<sub>stg</sub> -65 to +150 °C
- Allowable power dissipation P<sub>D</sub> 1020 mW

**Operating Conditions**

Supply voltage (V<sub>CC</sub> • V<sub>EE</sub>) ±6.5 to 8.0 V

\* These ICs are available only to the licensees of Dolby Laboratories Licensing Corporation from whom licensing and applications information may be obtained.  
\* "Dolby" and the double D symbols are trade marks of Dolby Laboratories Licensing Corporation.

Sony reserves the right to change products and specifications without prior notice. This information does not convey any license by any implication or otherwise under any patents or other right. Application circuits shown, if any, are typical examples illustrating the operation of the devices. Sony cannot assume responsibility for any problems arising out of the use of these circuits.

Block Diagram and Pin Configuration

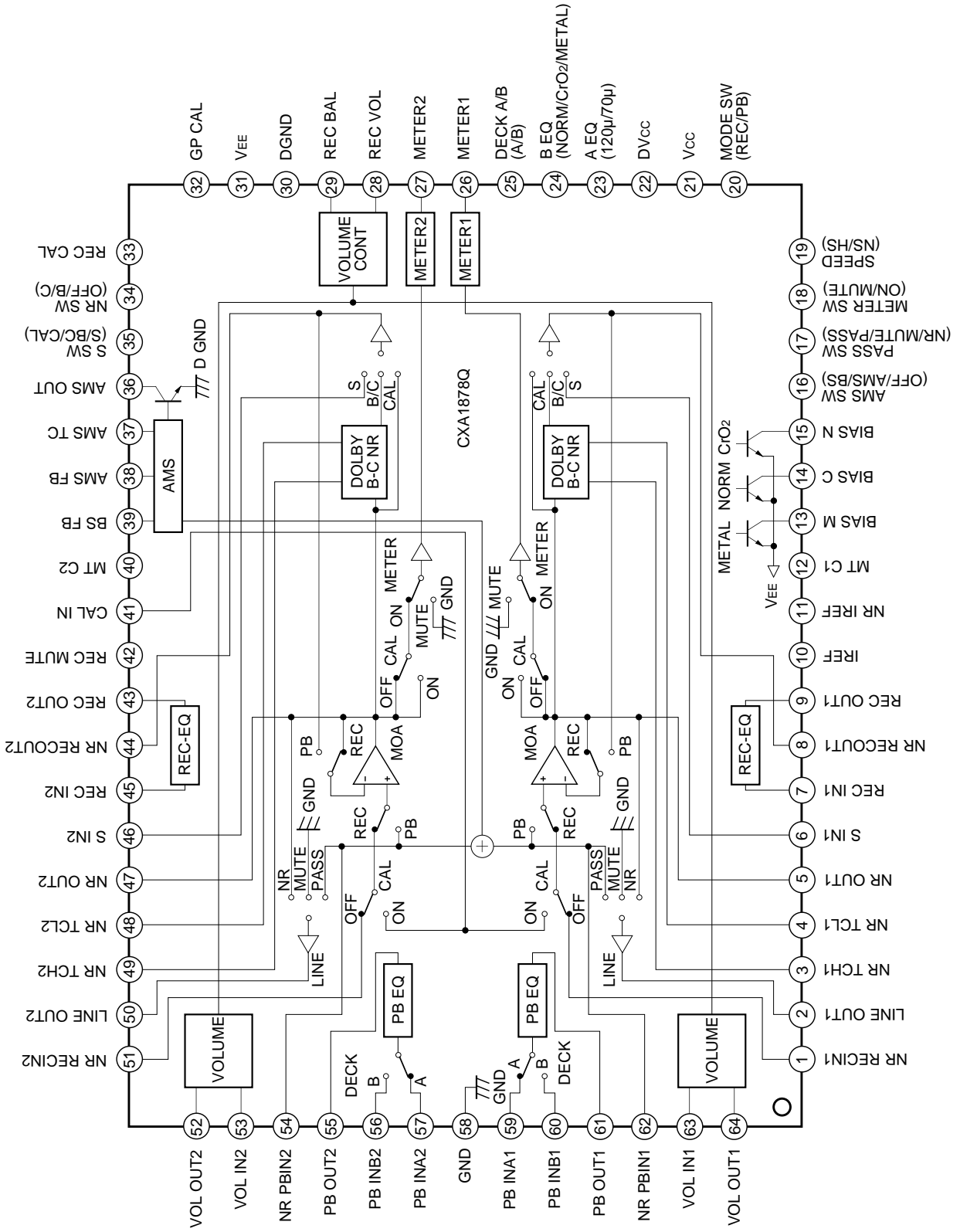

Pin Description

(Ta = 25°C, VCC = 7.0V, VEE = -7.0V, DVCC = 5.0V)

Pin No.	Symbol	Typical pin voltage		I/O	Z (in)	Equivalent circuit	Description
		DC	AC				
1 51	NR RECIN1 NR RECIN2	0.0V	-26dBv	I	40kΩ		Recording equalizer amplifier input
2 50	LINE OUT1 LINE OUT2	0.0V	-4dBv	O	—		Line output
3 49	NR TCH1 NR TCH2	VEE +0.4V	—	—	—		Time constant for the HLS
4 48	NR TCL1 NR TCL2	VEE +0.4V	—	—	—		Time constant for the LLS

Pin No.	Symbol	Typical pin voltage		I/O	Z (in)	Equivalent circuit	Description
		DC	AC				
5 47	NR OUT1 NR OUT2	0.0V	-6dBm (-7dBv)	O	—		Dolby S type NR output
6 46	S IN1 S IN2	0.0V	-6dBm (-7dBv)	I	40kΩ		Dolby S type NR input
7 45	REC IN1 REC IN2	0.0V	-24dBv	I	50kΩ		Recording equalizer amplifier input
8 44	NR RECOUT1 NR RECOUT2	0.0V	-6dBm (-7dBv)	O	—		Dolby NR recording signal output

Pin No.	Symbol	Typical pin voltage		I/O	Z (in)	Equivalent circuit	Description
		DC	AC				
9 43	REC OUT1 REC OUT2	0.0V	-3dBv	O	—		Recording equalizer amplifier output
10	IREF	$V_{EE}$ +1.2V	—	—	—		Reference current setting for built-in recording/playback equalizer amplifier * The reference current can be set by connecting a resistor between this pin and $V_{EE}$ .
11	NR IREF	$V_{EE}$ +1.2V	—	—	—		Reference current setting for built-in Dolby NR * The reference current can be set by connecting a resistor between this pin and $V_{EE}$ .
12 40	MT C1 MT C2	0.0V	—	O	—		DC cut capacitance

Pin No.	Symbol	Typical pin voltage		I/O	Z (in)	Equivalent circuit	Description
		DC	AC				
13 14 15	BIAS M BIAS C BIAS N	—	—	O	—		Recording bias control voltage output
16	AMS SW	2.5V when open	—	I	—		AMS mode control * Mode select switch for AMS/BS amplifier High: BS mode Medium: AMS mode Low: AMS/BS OFF mode [BS mode = Music signal interval detection during playback] [AMS mode = Music signal detection during FF/REW]
17	PASS SW	2.5V when open	—	I	—		PASS mode control H : PASS M : MUTE L : NR ON
18	METER SW	—	—	I	—		Meter mode control * Meter amplifier output ON/OFF select switch High: Meter output OFF (mute) Low : Meter output ON

Pin No.	Symbol	Typical pin voltage		I/O	Z (in)	Equivalent circuit	Description
		DC	AC				
19	SPEED	—	—	I	—		Tape speed selection * Normal speed/ double speed selection High : Double speed Low : Normal speed
20	MODE SW	—	—	I	—		Recording/playback mode control * Recording/playback mode selection High : Recording mode Low : Playback mode
21	V <sub>cc</sub>	7.0V	—	I	—		Positive power supply
22	DV <sub>cc</sub>	5.0V	—	I	—		Reference power supply for mode control
23	A EQ	2.5V when open	—	I	—		Deck A playback equalizer amplifier control * 120μs/70μs selection High : 70μs Low : 120μs (Built-in equalizer amplifier flat)
24	B EQ	2.5V when open	—	I	—		Control of deck B playback equalizer amplifier mode, recording equalizer amplifier mode, and recording bias mode * NORM/CrO <sub>2</sub> /METAL selection High : METAL Medium : CrO <sub>2</sub> Low : NORM

Pin No.	Symbol	Typical pin voltage		I/O	Z (in)	Equivalent circuit	Description
		DC	AC				
25	DECK A/B	—	—	I	—		Playback deck A/B select control * Playback equalizer amplifier input selection High : PB INB Low : PB INA
26 27	METER1 METER2	1.6V	-1.1dBv	O	—		Level meter amplifier output
28	REC VOL	—	—	I	100kΩ		Recording volume level control High : Output signal level increased Low : Output signal level reduced
29	REC BAL	2.5V when open	—	I	100kΩ		Recording volume balance control High : Only VOL OUT2 output level reduced Low : Only VOL OUT1 output level reduced * Neither VOL OUT1 nor 2 output levels are attenuated at the control voltage of 2.5V.
30	DGND	0.0V					Connect to GND.



Pin No.	Symbol	Typical pin voltage		I/O	Z (in)	Equivalent circuit	Description
		DC	AC				
31	V <sub>EE</sub>	-7.0V					Negative power supply
32	GP CAL	2.5V when open	—	I	54kΩ		Recording equalizer amplifier high frequency calibration * Controlled with DC voltages of 0 to 5V. High: High frequency level gain increased Low: High frequency level gain reduced * Leave this pin open when not using the high frequency calibration function.
33	REC CAL	2.5V when open	—	I	54kΩ		Recording equalizer amplifier calibration * Controlled with DC voltages of 0 to 5V. High: Recording level gain increased Low: Recording level gain reduced * Leave this pin open when not using the recording calibration function.
34	NR SW	2.5V when open	—	I	50kΩ		NR control High: C type Medium: B type Low: NR OFF
35	S SW	2.5V when open	—	I	50kΩ		Dolby S type selection * Select the calibration mode with this pin. High: CALIBRATION Medium: B-C type Low: S type

Pin No.	Symbol	Typical pin voltage		I/O	Z (in)	Equivalent circuit	Description
		DC	AC				
36	AMS OUT	0.0V	—	O	—		AMS amplifier output
37	AMS TC	0.0V	—	—	—		Time constant for the AMS
38	AMS FB	0.0V	—	—	—		Feedback during AMS mode
39	BS FB	0.0V	—	—	—		Feedback during BS mode

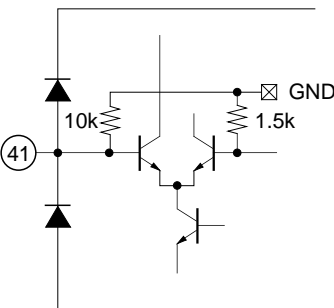
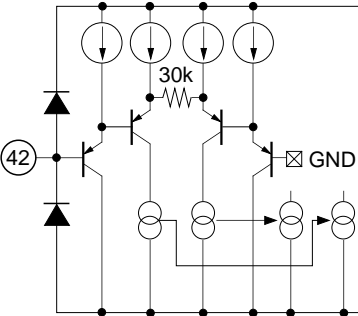
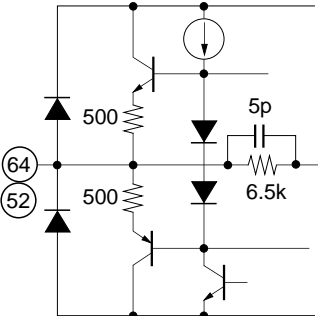
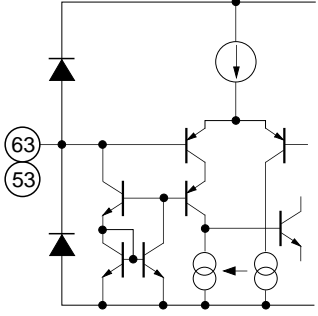
Pin No.	Symbol	Typical pin voltage		I/O	Z (in)	Equivalent circuit	Description
		DC	AC				
41	CAL IN	0.0V	-26dBv	I	10kΩ		Calibration signal input
42	REC MUTE	—	—	I	—		<p>Recording mute ON/OFF selection</p> <p>* The recording mute is controlled with DC voltages of 0 to 5V. High: Recording mute OFF Low: Recording mute ON</p> <p>* Soft mute and fader functions can be set by changing the time constant of the external time constant circuit.</p>
64 52	VOL OUT1 VOL OUT2	0.0V	-10dBv	O			Recording volume amplifier output
63 53	VOL IN1 VOL IN2	0.0V	-10dBv	I	50kΩ		Recording volume amplifier input

Pin No.	Symbol	Typical pin voltage		I/O	Z (in)	Equivalent circuit	Description
		DC	AC				
62 54	NR PBIN1 NR PBIN2	0.0V	-11dBv	I	40kΩ		Dolby NR playback input
61 55	PB OUT1 PB OUT2	0.0V	-11dBv	I	—		Playback equalizer amplifier output
59 60 57 56	PB INA1 PB INB1 PB INA2 PB INB2	0.0V	-31dBv	I	50kΩ		Playback equalizer amplifier input
58	GND	0.0V	—	—	—		Ground

Electrical Characteristics Measurement Circuit

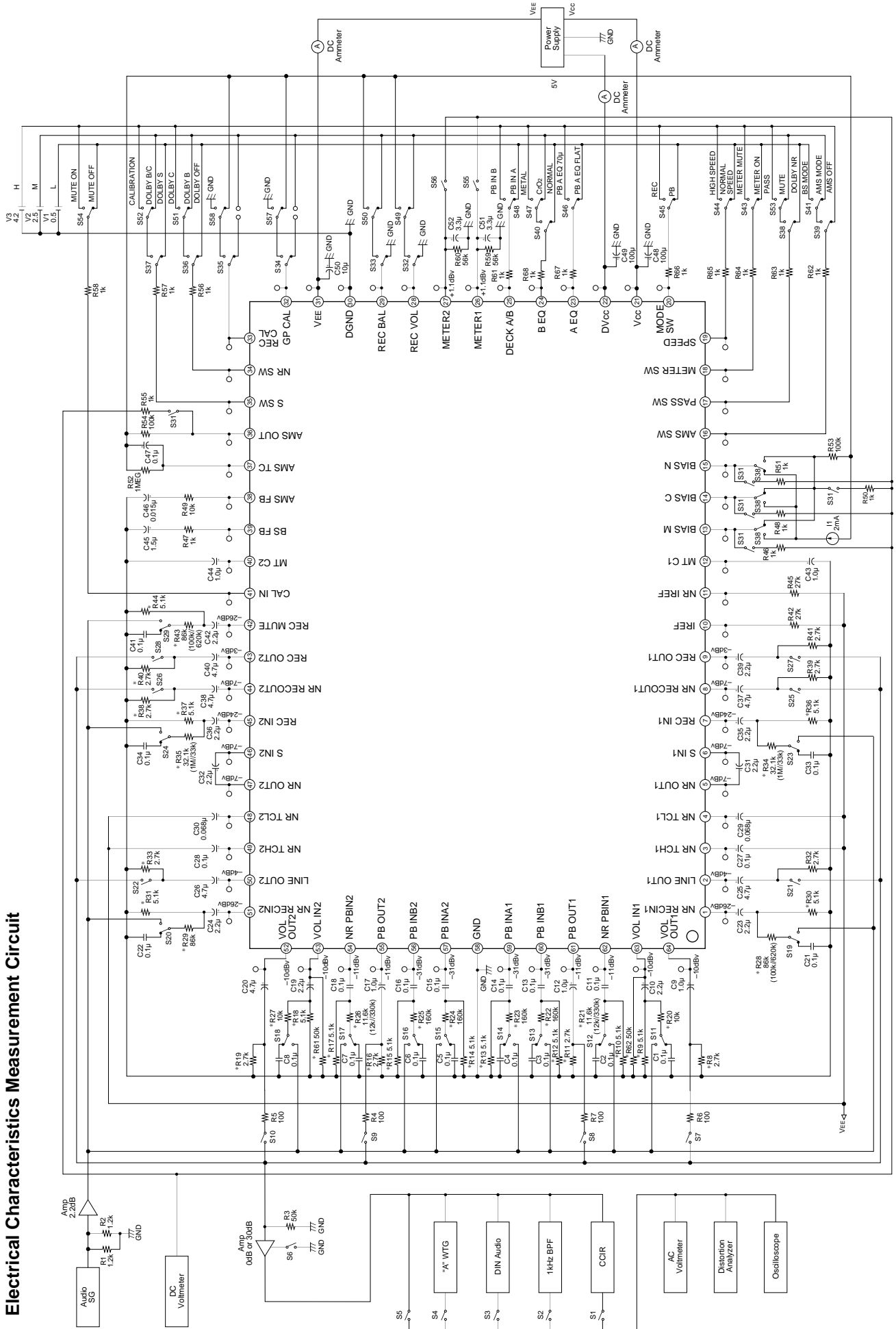

Application Circuit

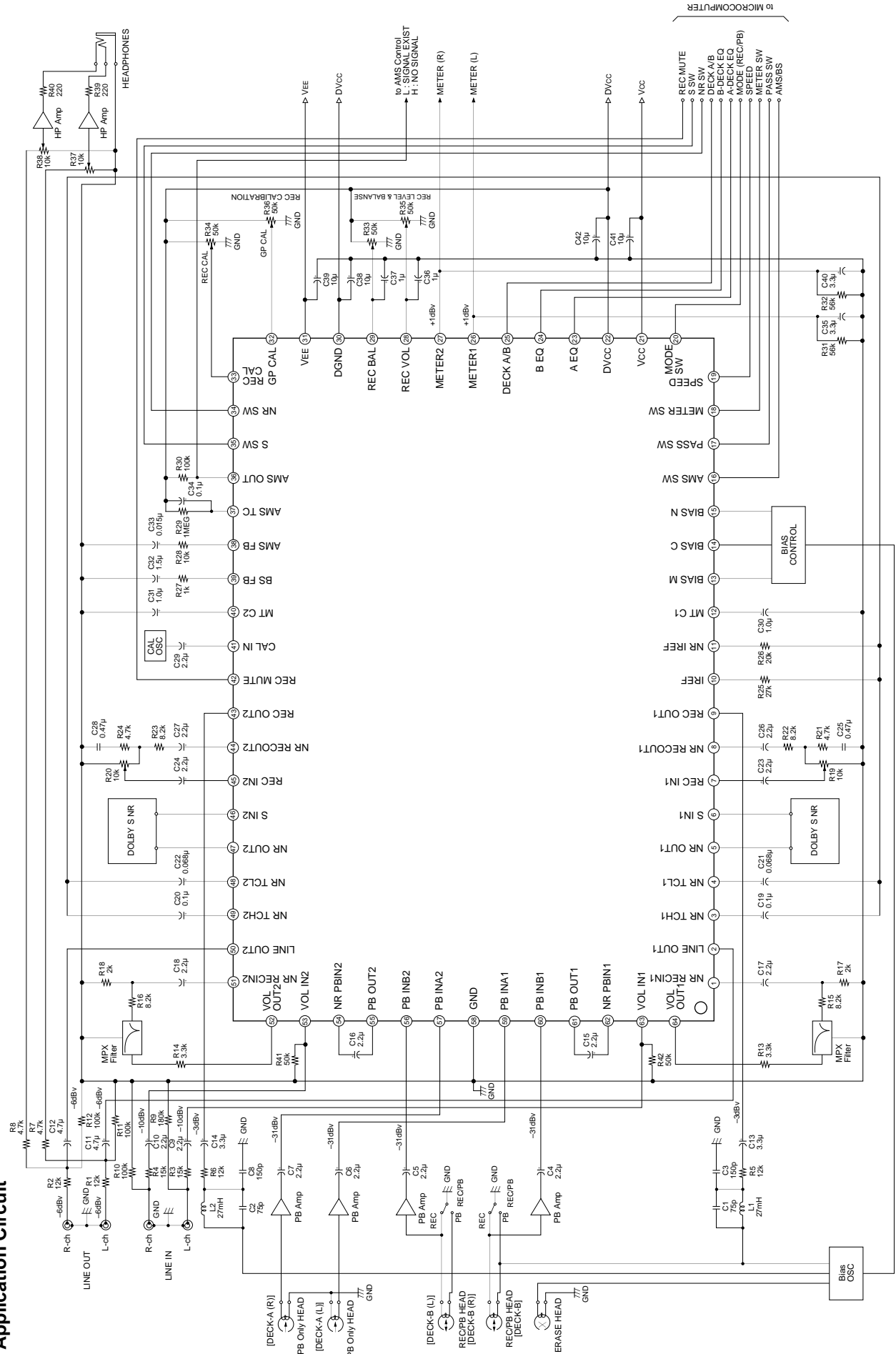

(Ta = 25°C, Vcc = 7.0V, VEE = -7.0V)

Electrical Characteristics

Block	Item	Conditions	Min.	Typ.	Max.	Unit
Entire LSI	Current consumption (ICC)		28	38	48	mA
Entire LSI	Operating voltage range (positive/negative dual power supplies)		±6.5	±7.0	±8.0	V
Recording equalizer amplifier	Recording equalizer amplifier Recording reference output level NORM-NORM mode	Recording equalizer amplifier reference output level (315Hz) (This output level is the tape reference 0dB which generates magnetic flux of 250nWb/m) All of the recording equalizer amplifier blocks use this level as their reference level.	—	-3.0	—	dBv
Recording equalizer amplifier	Recording equalizer amplifier Recording reference input level NORM-NORM mode	Input level when the reference output level is 315Hz, -3.0dBv (For measurement, input a 315Hz, -24.5dBv signal to the REC EQ IN pins (Pins 7 and 45) and then measure the output level.)	-26	-24.5	-23	dBv
Recording equalizer amplifier	NORM-NORM mode REC-EQ frequency response 1 (3kHz, -20dB)	NORM-tape, NORM-speed mode Input a 3kHz signal (-20dB level down) to the REC EQ IN pin and then measure the relative deviation from NORM-NS, 315Hz mode.	-1.9	-0.4	1.0	dB
Recording equalizer amplifier	NORM-NORM mode REC-EQ frequency response 2 (8kHz, -20dB)	NORM-tape, NORM-speed mode Input a 8kHz signal (-20dB level down) to the REC EQ IN pin and then measure the relative deviation from NORM-NS, 315Hz mode.	2.5	4.5	6.5	dB
Recording equalizer amplifier	NORM-NORM mode REC-EQ frequency response 3 (12kHz, -20dB)	NORM-tape, NORM-speed mode Input a 12kHz signal (-20dB level down) to the REC EQ IN pin and then measure the relative deviation from NORM-NS, 315Hz mode.	7.3	10.3	13.3	dB
Recording equalizer amplifier	CrO2-NORM mode REC-EQ frequency response 1 (3kHz, -20dB)	CrO2-tape, NORM-speed mode Input a 3kHz signal (-20dB level down) to the REC EQ IN pin and then measure the relative deviation from NORM-NS, 315Hz mode.	2.9	4.4	5.9	dB
Recording equalizer amplifier	CrO2-NORM mode REC-EQ frequency response 2 (8kHz, -20dB)	CrO2-tape, NORM-speed mode Input a 8kHz signal (-20dB level down) to the REC EQ IN pin and then measure the relative deviation from NORM-NS, 315Hz mode.	7.1	9.1	11.1	dB
Recording equalizer amplifier	CrO2-NORM mode REC-EQ frequency response 3 (12kHz, -20dB)	CrO2-tape, NORM-speed mode Input a 12kHz signal (-20dB level down) to the REC EQ IN pin and then measure the relative deviation from NORM-NS, 315Hz mode.	11.3	14.3	17.3	dB
Recording equalizer amplifier	METAL-NORM mode REC-EQ frequency response 1 (3kHz, -20dB)	METAL-tape, NORM-speed mode Input a 3kHz signal (-20dB level down) to the REC EQ IN pin and then measure the relative deviation from NORM-NS, 315Hz mode.	3.9	5.4	6.9	dB

Block	Item	Conditions	Min.	Typ.	Max.	Unit
Recording equalizer amplifier	METAL-NORM mode REC-EQ frequency response 2 (8kHz, -20dB)	METAL-tape, NORM-speed mode Input a 8kHz signal (-20dB level down) to the REC EQ IN pin and then measure the relative deviation from NORM-NS, 315Hz mode.	7.1	9.1	11.1	dB
Recording equalizer amplifier	METAL-NORM mode REC-EQ frequency response 3 (12kHz, -20dB)	METAL-tape, NORM-speed mode Input a 12kHz signal (-20dB level down) to the REC EQ IN pin and then measure the relative deviation from NORM-NS, 315Hz mode.	10.4	13.4	16.4	dB
Recording equalizer amplifier	NORM-HIGH mode REC-EQ frequency response 1 (5kHz, -20dB)	NORM-tape, HIGH-speed mode Input a 5kHz signal (-20dB level down) to the REC EQ IN pin and then measure the relative deviation from NORM-NS, 315Hz mode.	-1.3	0.2	1.7	dB
Recording equalizer amplifier	NORM-HIGH mode REC-EQ frequency response 2 (15kHz, -20dB)	NORM-tape, HIGH-speed mode Input a 15kHz signal (-20dB level down) to the REC EQ IN pin and then measure the relative deviation from NORM-NS, 315Hz mode.	4.0	6.5	9.0	dB
Recording equalizer amplifier	NORM-HIGH mode REC-EQ frequency response 3 (20kHz, -20dB)	NORM-tape, HIGH-speed mode Input a 20kHz signal (-20dB level down) to the REC EQ IN pin and then measure the relative deviation from NORM-NS, 315Hz mode.	7.4	10.9	14.4	dB
Recording equalizer amplifier	CrO <sub>2</sub> -HIGH mode REC-EQ frequency response 1 (5kHz, -20dB)	CrO <sub>2</sub> -tape, HIGH-speed mode Input a 5kHz signal (-20dB level down) to the REC EQ IN pin and then measure the relative deviation from NORM-NS, 315Hz mode.	3.9	5.4	6.9	dB
Recording equalizer amplifier	CrO <sub>2</sub> -HIGH mode REC-EQ frequency response 2 (15kHz, -20dB)	CrO <sub>2</sub> -tape, HIGH-speed mode Input a 15kHz signal (-20dB level down) to the REC EQ IN pin and then measure the relative deviation from NORM-NS, 315Hz mode.	8.6	11.1	13.6	dB
Recording equalizer amplifier	CrO <sub>2</sub> -HIGH mode REC-EQ frequency response 3 (20kHz, -20dB)	CrO <sub>2</sub> -tape, HIGH-speed mode Input a 20kHz signal (-20dB level down) to the REC EQ IN pin and then measure the relative deviation from NORM-NS, 315Hz mode.	11.4	14.9	18.4	dB
Recording equalizer amplifier	METAL-HIGH mode REC-EQ frequency response 1 (5kHz, -20dB)	METAL-tape, HIGH-speed mode Input a 5kHz signal (-20dB level down) to the REC EQ IN pin and then measure the relative deviation from NORM-NS, 315Hz mode.	5.9	7.4	8.9	dB
Recording equalizer amplifier	METAL-HIGH mode REC-EQ frequency response 2 (15kHz, -20dB)	METAL-tape, HIGH-speed mode Input a 15kHz signal (-20dB level down) to the REC EQ IN pin and then measure the relative deviation from NORM-NS, 315Hz mode.	9.5	12.0	14.5	dB
Recording equalizer amplifier	METAL-HIGH mode REC-EQ frequency response 3 (20kHz, -20dB)	METAL-tape, HIGH-speed mode Input a 20kHz signal (-20dB level down) to the REC EQ IN pin and then measure the relative deviation from NORM-NS, 315Hz mode.	11.8	15.3	18.8	dB



Block	Item	Conditions	Min.	Typ.	Max.	Unit
Recording equalizer amplifier	NORM-NORM mode REC-EQ signal handling (1kHz, THD = 1%, R <sub>L</sub> = 2.7kΩ)	NORM-tape, NORM-speed mode, R <sub>L</sub> = 2.7kΩ Input a 1kHz signal and set the output level so that THD (total harmonic distortion) is 1%. (Measure the distortion of a +11dB level-up signal.)	11.0	12.4	—	dB
Recording equalizer amplifier	NORM-NORM mode REC-EQ total harmonic distortion (1kHz, 0.0dB, R <sub>L</sub> = 2.7kΩ)	NORM-tape, NORM-speed mode, R <sub>L</sub> = 2.7kΩ Input a 1kHz, 0dB (reference input level) signal and measure the distortion. (Measure the distortion as THD + N.)	—	0.14	0.6	%
Recording equalizer amplifier	NORM-NORM mode REC-EQ S/N ratio ("A"-WGT filter)	NORM-tape, NORM-speed mode, R <sub>g</sub> = 5.1kΩ With no signal, measure the noise using the "A"-WGT filter. (The measured value is indicated as the relative value compared to the reference level.)	57.0	65.0	—	dB
Recording equalizer amplifier	NORM-NORM mode Output DC offset voltage (REC OUT pin)	NORM-tape, NORM-speed mode	-500	10.0	500	mV
Recording equalizer amplifier	NORM-NORM mode REC-EQ mute characteristics 1 (REC-MUTE = 0.5V)	NORM-tape, NORM-speed mode, REC-MUTE = 0.5V Input a 1kHz signal (+12dB level up) and measure the attenuation when REC MUTE is ON. (Use a 1kHz BPF.)	—	-99.9	-80	dB
Recording equalizer amplifier	NORM-NORM mode REC-EQ mute characteristics 2 (REC-MUTE = 2.5V)	NORM-tape, NORM-speed mode, REC-MUTE = 2.5V Input a 1kHz, 0dB (reference level) signal and measure the attenuation characteristics curve of the soft mute function (when REC-MUTE = 2.5V).	-8.1	-6.6	-5.1	dB
Recording equalizer amplifier	NORM-NORM mode REC-EQ REC-CAL characteristics 1 (REC-CAL = 5.0V)	NORM-tape, NORM-speed mode, REC-CAL = 5.0V Input a 315Hz signal (-20dB level down) and measure the amount of change compared to when the REC-CAL function is at the standard setting.	4.8	6.3	7.8	dB
Recording equalizer amplifier	NORM-NORM mode REC-EQ REC-CAL characteristics 2 (REC-CAL = 0.0V)	NORM-tape, NORM-speed mode, REC-CAL = 0.0V Input a 315Hz signal (-20dB level down) and measure the amount of change compared to when the REC-CAL function is at the standard setting.	-7.5	-6.0	-4.5	dB
Recording equalizer amplifier	NORM-NORM mode REC-EQ Gp-CAL characteristics 1 (Gp-CAL = 5.0V)	NORM-tape, NORM-speed mode, Gp-CAL = 5.0V Input a 8kHz signal (-20dB level down) and measure the amount of change compared to when the Gp-CAL function is at the standard setting.	2.7	4.2	5.7	dB
Recording equalizer amplifier	NORM-NORM mode REC-EQ Gp-CAL characteristics 2 (Gp-CAL = 0.0V)	NORM-tape, NORM-speed mode, Gp-CAL = 0.0V Input a 8kHz signal (-20dB level down) and measure the amount of change compared to when the Gp-CAL function is at the standard setting.	-4.8	-3.3	-1.8	dB
Recording volume	Recording volume amplifier Recording volume characteristics 1 (REC-VOL = 5.0V, REC-BAL = 2.5V)	REC-VOL = 5.0V, REC-BAL = 2.5V Input a 1kHz, -10dBv signal to the VOL IN pin and measure the full gain of the recording volume amplifier.	8.0	9.0	10.0	dB

Block	Item	Conditions	Min.	Typ.	Max.	Unit
Recording volume	Recording volume amplifier Recording volume characteristics 2 (REC-VOL = 2.0V, REC-BAL = 2.5V)	REC-VOL = 2.0V, REC-BAL = 2.5V Input a 1kHz, -10dBv signal to the VOL IN pin and measure the attenuation of the recording volume amplifier.	-9.4	-8.4	-7.4	dB
Recording volume	Recording volume amplifier Recording volume attenuation (REC-VOL = 0.0V, REC-BAL = 2.5V)	REC-VOL = 0.0V, REC-BAL = 2.5V Input a 1kHz, +2dBv signal and measure the maximum volume attenuation of the recording volume amplifier. (Use a 1kHz BPF.)	—	-104.7	-80	dB
Recording volume	Recording volume amplifier REC-VOL signal handling (1kHz, THD = 1%, RL = 2.7kΩ)	REC-VOL = 2.0V, REC-BAL = 2.5V, RL = 2.7kΩ Input a 1kHz signal and set the input level so that the THD is 1%. (Measure the distortion when the output is +2dBv.)	2.0	3.41	—	dBv
Recording volume	Recording volume amplifier REC-VOL total harmonic distortion (1kHz, -6.0dBv, RL = 2.7kΩ)	REC-VOL = 2.0V, REC-BAL = 2.5V, RL = 2.7kΩ Input a 1kHz, -10dBv signal (reference input level) and measure the distortion. (Measure the distortion as THD + N.)	—	0.09	0.5	%
Recording volume	Recording volume amplifier REC-VOL S/N ratio ("A"-WGT filter)	REC-VOL = 5.0V, REC-BAL = 2.5V With no signal, measure the noise using an "A"-WGT filter. (The measured value is indicated as the relative value compared to the full-gain level.)	80	97.5	—	dB
Recording volume	Recording volume amplifier Output DC offset voltage (VOL OUT pin)	REC-VOL = 5.0V, REC-BAL = 2.5V With no signal, measure the DC offset voltage of the VOL OUT pin.	-150	4.2	150	mV
Recording volume	Recording volume amplifier REC-VOL balance characteristics 1 (REC-VOL = 5.0V, REC-BAL = 0.0V)	REC-VOL = 5.0V, REC-BAL = 0.0V, (1kHz BPF) Input a 1kHz, +2dBv signal and measure the attenuation of VOL OUT 1. (Input a -10dBv signal and confirm that there is no attenuation at VOL OUT 2.)	—	-93.2	-60	dB
Recording volume	Recording volume amplifier REC-VOL balance characteristics 2 (REC-VOL = 5.0V, REC-BAL = 5.0V)	REC-VOL = 5.0V, REC-BAL = 5.0V, (1kHz BPF) Input a 1kHz, +2dBv signal and measure the attenuation of VOL OUT 2. (Input a -10dBv signal and confirm that there is no attenuation at VOL OUT 1.)	—	-93.2	-60	dB
Line amplifier	Line amplifier NR mode gain (NR PB IN = 1kHz, -11.0dBv)	NR mode Input a 1kHz, -11dBv signal to the NR PB IN pin and measure the gain.	6.0	7.0	8.0	dB
Line amplifier	Line amplifier PASS mode gain (NR PB IN = 1kHz, -11.0dBv)	PASS mode Input a 1kHz, -11dBv signal to the NR PB IN pin and measure the gain.	6.0	7.0	8.0	dB
Line amplifier	Line amplifier Signal handling (1kHz, THD = 1%, RL = 2.7kΩ)	PASS mode, RL = 2.7kΩ Input a 1kHz signal and set the output level so that the THD is 1%. (Measure the distortion when the output is +1dBv.)	12.0	15.5	—	dB

Block	Item	Conditions	Min.	Typ.	Max.	Unit
Line amplifier	Line amplifier Line amplifier total harmonic distortion (1kHz, -11.0dBv, R <sub>L</sub> = 2.7kΩ)	PASS mode, R <sub>L</sub> = 2.7kΩ Input a 1kHz, +1dBv signal (reference input level) and measure the distortion. (Measure the distortion as THD + N.)	—	0.07	1.0	%
Line amplifier	Line amplifier Line amplifier S/N ratio ("A"-WGT filter)	PASS mode, R <sub>g</sub> = 5.1kΩ With no signal, measure the noise using the "A"-WGT filter. (The measured value is indicated as the relative value compared to the reference level.)	80	84.1	—	dB
Line amplifier	Line amplifier Output DC offset voltage (LINE OUT pin)	PASS mode With no signal, measure the DC offset voltage of the LINE OUT pin.	-200	0	200	mV
Line amplifier	Line amplifier MUTE mode characteristics (1kHz BPF)	MUTE mode Input a 1kHz, +1dBv signal to the NR PB IN pin and measure the attenuation when LINE MUTE is on. (Use a 1kHz BPF.)	—	-111	-80	dB
Level meter	Level meter amplifier Level meter characteristics 1 (PASS IN = 1kHz, -11dBv)	METER ON, CAL OFF, PB Input a 1kHz, -11dBv signal to the NR PB IN pin and measure the output DC voltage at the METER pin.	1.34	1.64	1.94	V
Level meter	Level meter amplifier Level meter characteristics 2 (PASS IN = 1kHz, -21dBv)	METER ON, CAL OFF, PB Input a 1kHz, -21dBv (-10dB level down) signal to the NR PB IN pin and measure the output DC voltage at the METER pin.	0.2	0.5	0.8	V
Level meter	Level meter amplifier Level meter CAL characteristics (PASS IN = 1kHz, -28dBv)	METER ON, CAL ON, REC Input a 1kHz, -28dBv (-17dB level down) signal to the NR PB IN pin and measure the output DC voltage at the METER pin.	1.3	1.6	1.9	V
Level meter	Level meter amplifier Level meter MUTE characteristics (PASS IN = 1kHz, +1.0dBv)	METER MUTE ON, PB Input a 1kHz, +1dBv (12dB level up) signal to the NR PB IN pin and measure the output DC voltage at the METER pin.	—	3.0	50.0	mV
Playback equalizer amplifier	120μs, DECK-A mode Playback reference output level (Playback equalizer amplifier gain)	DECK-A, A-EQ = 120μs, NORM-speed mode Input a 315Hz, -31dBv (reference input level) signal to the PB IN pin and measure the output level.	-11.9	-10.9	-9.9	dBv
Playback equalizer amplifier	Playback equalizer amplifier PB-EQ frequency response 1 (120μs-NS, DECK-A mode)	DECK-A, A-EQ = 120μs, NORM-speed mode Input a 5kHz, -31dBv (reference input level) signal and then measure the relative deviation from the 120μs-NS, 315Hz mode.	-1.0	0.0	1.0	dB
Playback equalizer amplifier	Playback equalizer amplifier PB-EQ frequency response 2 (70μs-NS, DECK-A mode)	DECK-A, A-EQ = 70μs, NORM-speed mode Input a 5kHz, -31dBv (reference input level) signal and then measure the relative deviation from the 120μs-NS, 315Hz mode.	-5.7	-4.2	-2.7	dB

Block	Item	Conditions	Min.	Typ.	Max.	Unit
Playback equalizer amplifier	Playback equalizer amplifier PB-EQ frequency response 3 120µs-NS, DECK-A mode	DECK-A, A-EQ = 120µs, HIGH-speed mode Input a 5kHz, -31dBv (reference input level) signal and then measure the relative deviation from the 120µs-NS, 315Hz mode.	-6.8	-5.3	-3.8	dB
Playback equalizer amplifier	Playback equalizer amplifier PB-EQ frequency response 4 70µs-NS, DECK-A mode	DECK-A, A-EQ = 70µs, HIGH-speed mode Input a 5kHz, -31dBv (reference input level) signal and then measure the relative deviation from the 120µs-NS, 315Hz mode.	-10.1	-8.6	-7.1	dB
Playback equalizer amplifier	120µs-NS, DECK-A mode PB-EQ signal handling (1kHz, THD = 1%, RL = 2.7kΩ)	DECK-A, A-EQ = 120µs, NORM-speed mode, RL = 2.7kΩ Input a 1kHz signal and set the output level so that the THD is 1%. (Measure the distortion of a +12dB level-up signal.)	12	22	—	dB
Playback equalizer amplifier	120µs-NS, DECK-A mode PB-EQ total harmonic distortion (1kHz, 0.0dB, RL = 2.7kΩ)	DECK-A, A-EQ = 120µs, NORM-speed mode, RL = 2.7kΩ Input a 1kHz, -31dBv (reference input level) signal and measure the distortion. (Measure the distortion as THD + N.)	—	0.03	0.5	%
Playback equalizer amplifier	120µs-NS, DECK-A mode PB-EQ S/N ratio ("A"-WGT filter)	DECK-A, A-EQ = 120µs, NORM-speed mode, Rg = 5.1kΩ With no signal, measure the noise using the "A"-WGT filter. (The measured value is indicated as the relative value compared to the reference level.)	70	75.6	—	dB
Playback equalizer amplifier	120µs-NS, DECK-A mode Output DC offset voltage (PB OUT pin)	DECK-A, A-EQ = 120µs, NORM-speed mode With no signal, measure the DC offset voltage of the PB OUT pin.	-200	-5	200	mV
Playback equalizer amplifier	Recording equalizer amplifier DECK-A/B switching characteristics 120µs-NS, DECK-B mode	DECK-B, B-EQ = NORM-tape, NORM-speed mode Input a 1kHz, -31dBv (reference input level) signal to the DECK-B side and then measure the relative deviation from the DECK-A, 120µs-NS, 315Hz mode.	-1.0	0.0	1.0	dB
AMS/BS amplifier	AMS/BS amplifier AMS signal detection level AMS mode	AMS mode, fin = 5kHz, reference level -11dBv Input level when the AMS OUT pin level changes from high to low. Input the signal to the NR PB IN pin and measure the level at the AMS OUT pin.	-15.0	-10.0	-5.0	dB
AMS/BS amplifier	AMS/BS amplifier BS signal detection level BS mode	BS mode, fin = 5kHz, reference level -11dBv Input level when the AMS OUT pin level changes from high to low. Input the signal to the NR PB IN pin and measure the level at the AMS OUT pin.	-35.5	-30.5	-25.5	dB
AMS/BS amplifier	AMS/BS amplifier AMS output leak current (AMS OUT pin)	AMS OFF mode Input a 5kHz, -11dBv signal to the NR PB IN pin and measure the current flowing to the AMS OUT pin.	—	0.88	1.0	µA

Block	Item	Conditions	Min.	Typ.	Max.	Unit
AMS/BS amplifier	AMS/BS amplifier AMS output saturation voltage (AMS OUT pin)	AMS mode Input a 5kHz, -11dBV signal to the NR PB IN pin and measure the output voltage when a 1mA current flows to the AMS OUT pin.	—	0.17	1.0	V
BIAS SW	BIAS N output voltage (NORMAL mode)	Input a 2mA signal to the BIAS N pin and measure the DC output voltage at the BIAS N pin.	—	0.4	0.6	V
BIAS SW	BIAS C output voltage (CrO <sub>2</sub> mode)	Input a 2mA signal to the BIAS C pin and measure the DC output voltage at the BIAS C pin.	—	0.4	0.6	V
BIAS SW	BIAS M output voltage (METAL mode)	Input a 2mA signal to the BIAS M pin and measure the DC output voltage at the BIAS M pin.	—	0.4	0.6	V
DOLBY	Dolby level	REC mode, NR OFF 1kHz, assume Dolby level of -6dBm as 0dB.	—	-6.0	—	dBm
DOLBY	REC mode REC IN level	REC mode, NR OFF, f = 1kHz Input a signal to the REC IN pin and measure the level at which the level of the DOLBY OUT pin reaches -6dBm.	-26	-25	-24	dBm
DOLBY	REC mode CAL IN level	REC mode, NR OFF, f = 1kHz Input a signal to the CAL IN pin and measure the level at which the level of the DOLBY OUT pin reaches -6dBm.	-26	-25	-24	dBm
DOLBY	PB mode PB IN level	PB mode, NR OFF, f = 1kHz Input a signal to the NR PB IN pin and measure the level at which the level of the DOLBY OUT pin reaches -6dBm.	-11	-10	-9	dBm
DOLBY	B type encoding Boost characteristics 1	REC, Dolby B type mode Input a 500Hz, -25dB signal from the REC IN pin and measure the boost at the REC OUT pin.	1.4	2.9	4.4	dB
DOLBY	B type encoding Boost characteristics 2	REC, Dolby B type mode Input a 5kHz, -25dB signal from the REC IN pin and measure the boost at the REC OUT pin.	3.9	5.4	6.9	dB
DOLBY	B type encoding Boost characteristics 3	REC, Dolby B type mode Input a 10kHz, -40dB signal from the REC IN pin and measure the boost at the REC OUT pin.	9.7	10.4	11.4	dB
DOLBY	B type encoding Boost characteristics 4	REC, Dolby B type mode Input a 10kHz, 0dB signal from the REC IN pin and measure the boost at the REC OUT pin.	-1.1	0.4	1.9	dB

Block	Item	Conditions	Min.	Typ.	Max.	Unit
DOLBY	C type encoding Boost characteristics 1	REC, Dolby C type mode Input a 500Hz, -60dB signal from the REC IN pin and measure the boost at the REC OUT pin.	14.2	16.2	18.2	dB
DOLBY	C type encoding Boost characteristics 2	REC, Dolby C type mode Input a 500Hz, -25dB signal from the REC IN pin and measure the boost at the REC OUT pin.	7.2	9.2	11.2	dB
DOLBY	C type encoding Boost characteristics 3	REC, Dolby C type mode Input a 2kHz, -60dB signal from the REC IN pin and measure the boost at the REC OUT pin.	18.7	20.7	22.7	dB
DOLBY	C type encoding Boost characteristics 4	REC, Dolby C type mode Input a 2kHz, -25dB signal from the REC IN pin and measure the boost at the REC OUT pin.	5.4	7.4	9.4	dB
DOLBY	C type encoding Boost characteristics 5	REC, Dolby C type mode Input a 5kHz, -25dB signal from the REC IN pin and measure the boost at the REC OUT pin.	3.5	5.5	7.5	dB
DOLBY	C type encoding Boost characteristics 6	REC, Dolby C type mode Input a 10kHz, 0dB signal from the REC IN pin and measure the boost at the REC OUT pin.	-5.5	-3.5	-1.5	dB
DOLBY	PB mode Frequency response	PB, Dolby C type mode Input a 20kHz, -10dBm signal from the NR PB IN pin and measure the relative deviation from the REC OUT output NR OFF mode.	-1.5	0	1.5	dB
DOLBY	REC mode Signal handling	REC, NR OFF mode Input a 1kHz signal and set the output level so that the THD is 1%. (Measure the distortion using a +13.5dB level-up signal from the reference.)	13.5	15.4	—	dB
DOLBY	NR OFF total harmonic distortion	REC, NR OFF mode Input a 1kHz, +10dB signal from the REC IN pin and measure the distortion. (Measure the distortion as THD + N.)	—	0.04	0.5	%
DOLBY	Dolby B type total harmonic distortion	REC, Dolby B type mode Input a 1kHz, +10dB signal from the REC IN pin and measure the distortion. (Measure the distortion as THD + N.)	—	0.06	0.5	%
DOLBY	Dolby C type total harmonic distortion	REC, Dolby C type mode Input a 1kHz, +10dB signal from the REC IN pin and measure the distortion. (Measure the distortion as THD + N.)	—	0.09	0.5	%

Block	Item	Conditions	Min.	Typ.	Max.	Unit
DOLBY	REC mode Dolby C type S/N ratio	REC, Dolby C type mode, Rg = 5.1kΩ With no signal, measure the noise using the CCIR/ARM filter. (The measured value is indicated as the relative value compared to the DOLBY OUT level.)	60.0	61.0	—	dB
DOLBY	PB mode Recording → playback crosstalk	PB, NR OFF mode Input a 1kHz, +10dB signal from the REC IN pin and measure the REC → PB crosstalk. (Use a 1kHz BPF.)	—	-77.5	-70	dB
DOLBY	REC mode Playback → recording crosstalk	REC, NR OFF mode Input a 1kHz, +10dB signal from the NR PB IN pin and measure the PB → REC crosstalk. (Use a 1kHz BPF.)	—	-113	-70	dB
DOLBY	REC mode Output DC offset voltage (REC OUT pin)	REC mode, NR OFF → C type With no signal, measure the deviation in the output DC offset voltage at the REC OUT pin when switching from NR OFF mode to C type mode.	-100	0.0	100	mV
Control circuit	Mode control Control circuit high level	NR SW, S SW, DECK A/B, EQ, B EQ, and PASS SW pin voltages	4.2	—	Vcc	V
Control circuit	Mode control Control circuit medium level	NR SW, S SW, DECK A/B, EQ, B EQ, and PASS SW pin voltages	2.2	—	2.8	V
Control circuit	Mode control Control circuit low level	NR SW, S SW, DECK A/B, EQ, B EQ, and PASS SW pin voltages	0.0	—	0.5	V
Control circuit	Mode control Control circuit high level	AMS SW, MODE SW, SPEED, and METER SW pin voltages	3.5	—	Vcc	V
Control circuit	Mode control Control circuit low level	AMS SW, MODE SW, SPEED, and METER SW pin voltages	0.0	—	0.5	V

**Description of Operation**

The CXA1878Q is a Dolby B-C type NR system with a built-in recording/playback equalizer amplifier, electronic volume, AMS, BIAS SW, and meter circuit. In addition, this chip also contains an S type (CXA1417S/Q) select switch, enabling the construction of a 2-channel Dolby B-C-S type NR system by using the CXA1878Q together with two CXA1417S/Q encoder units.

The CXA1878Q has the circuit configuration shown in Fig. 1.

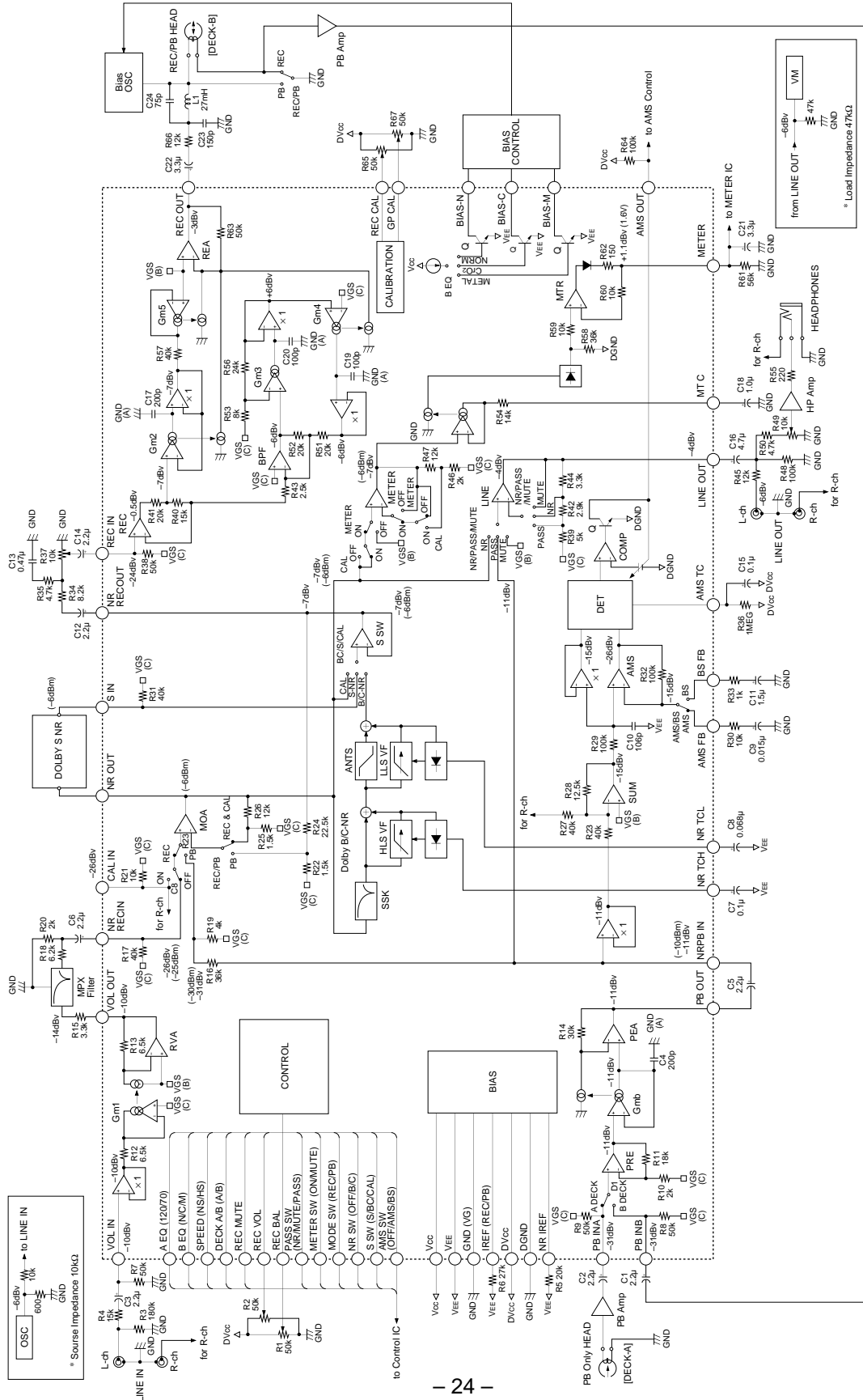

**Fig. 1. Functional block diagram**



**1. Reference levels**

(1) Recording equalizer amplifier output level (315Hz, -3dBv)  
 [\* when the recording equalizer amplifier input level is -24dBv]

(2) Playback equalizer amplifier output level (315Hz, -11dBv)  
 [\* when the playback equalizer amplifier input level is -31dBv]

(3) Dolby

The Dolby level is measured at the recording output pin (REC OUT) at -6dBm (388mVrms) in the NR OFF mode. Reference levels for the recording input pin (LINE IN), playback input pin (PB IN) and line output pin (LINE OUT) are defined as the levels which apply the Dolby level to REC OUT in the NR OFF mode.

**2. System control methods**

(1) Mode settings table

Pin No.	Symbol	Pin voltage			Remarks
		Low	Medium	High	
34	NR SW	DOLBY NR OFF	DOLBY NR ON B type	DOLBY NR ON C type	3-state
35	NR S SW	DOLBY S	DOLBY B-C*	CALIBRATION	3-state
16	AMS SW	AMS OFF	AMS MODE	BS MODE	3-state
20	MODE SW	PB	—	REC	2-state
19	SPEED	NORMAL SPEED	—	HIGH SPEED	2-state
25	DECK A/B	PB IN A	—	PB IN B	2-state
23	A EQ	PB IN A EQ FLAT	—	PB IN A EQ 70μ	2-state
24	B EQ	PB IN B EQ FLAT	PB IN B EQ 70μ	PB IN B EQ 70μ	3-state
		REC EQ NORMAL	REC EQ CrO <sub>2</sub>	REC EQ METAL	
		BIAS SW NORMAL	BIAS SW CrO <sub>2</sub>	BIAS SW METAL	
17	PASS SW	DOLBY NR	MUTE	PASS	3-state
18	METER SW	METER ON	—	METER OFF	2-state

**Note:** When 3-state input pins are open, the pin voltage is medium.

\* The NR SW (Pin 34) operates only when the NR S SW (Pin 35) is set to medium.

(2) Mode setting pin control voltage

	Control voltage	Min.	Max.
3-state	High level	4.2	Vcc
	Medium level	2.2	2.8
	Low level	0.0	0.5
2-state	High level	3.5	Vcc
	Low level	0.0	0.5

### 3. Recording mute function

The CXA1878Q recording mute function is implemented by using a built-in recording mute circuit which varies the recording equalizer amplifier gain according to the magnitude of the DC voltage applied to the REC MUTE pin just like an electronic volume control. Also, any desired soft mute or fader can be freely set depending on momentary changes in the DC voltage applied to the REC MUTE pin. Fig. 2 illustrates the recording mute waveforms.

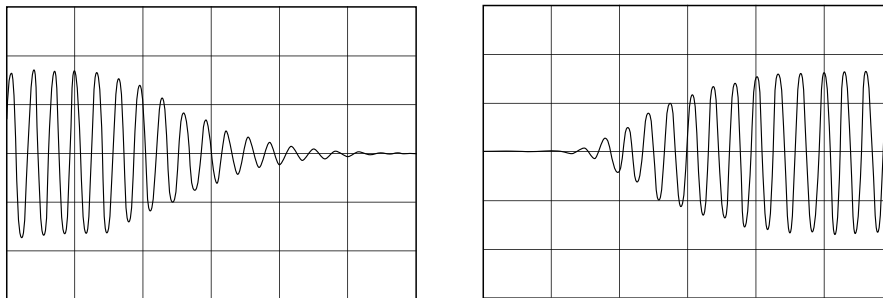

Fig. 2. Recording mute waveform

REC MUTE control voltage

Pin No.	Symbol	Pin voltage (V)					Remarks
		0.0	0.5	2.5	4.5	5.0	
42	REC MUTE	Decrease <<<< Increase					RECOUT attenuation (dB) NORM Tape, Norm-Speed, f = 1kHz
		Less than -90	-90	—	—	—	

### 4. Recording level calibration

The CXA1878Q allows the recording level to be finely adjusted with a DC voltage. Therefore, the recording level can be varied by approximately  $\pm 6$ dB simply by applying DC voltages of 0 to 5V (for dual power supply) to the REC CAL pin (Pin 33).

The table below shows the input range of control voltages with the power supplies used.\*1

Output level	Down (Vdown)	Typ.	Up (Vup)
REC CAL pin voltage	DGND to 2.5V	2.5V*2	2.5V to Vcc

\*1 Although the above range of voltages can be input to the control pin, the controllable input voltage range is as follows.

$$2.5V < V_{up} \leq 5.0V$$

$$DGND \leq V_{down} < 2.5V$$

\*2 Control voltages for this IC are referenced to the DGND pin (Pin 30).

Also note that when not using this recording level calibration function, simply leave the REC CAL pin (Pin 33) open, so that the voltage of the REC CAL pin is matched to the internal reference voltage (2.5V), with the recording level set for the standard gain.

**5. High frequency calibration**

The CXA1878Q allows the high frequency response of the recording equalizer to be finely adjusted with a DC voltage.

Therefore, the recording level in high frequencies (peak) can be varied by approximately  $\pm 4\text{dB}$  simply by applying DC voltages of 0 to 5V (for dual power supply) to the GP CAL pin (Pin 32). The table below shows the input range of control voltages with the power supplies used.\*3

Output level	Down (Vdown)	Typ.	Up (Vup)
GP CAL pin voltage	DGND to 2.5V	2.5V*4	2.5V to Vcc

\*3 Although the above range of voltages can be input to the control pin, the controllable input voltage range is as follows.

$$2.5\text{V} < V_{\text{up}} \leq 5.0\text{V}$$

$$\text{DGND} \leq V_{\text{down}} < 2.5\text{V}$$

\*4 Control voltages for this IC are referenced to the DGND pin (Pin 30).

Also note that when not using this high frequency calibration function, simply leave the GP CAL pin (Pin 32) open, so that the voltage of the GP CAL pin is matched to the internal reference voltage (2.5V), with the high frequency equalizer amplifier characteristics set for the standard gain.

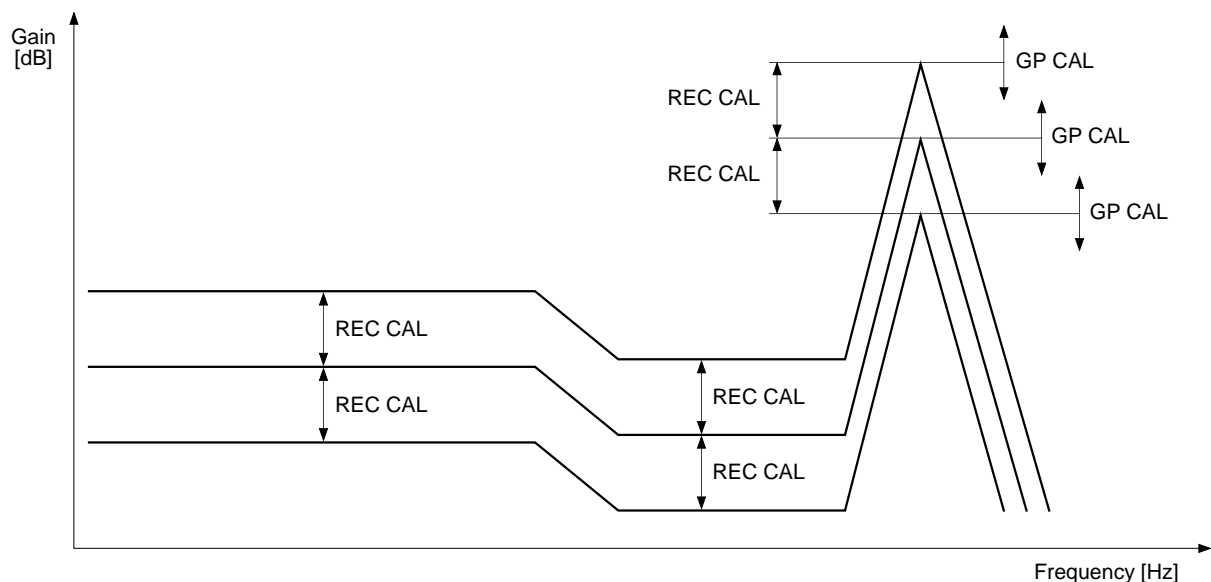

**Fig. 3. Conceptual diagram of the recording level/high frequency calibration functions**

**6. Meter circuit**

The CXA1878Q has a built-in full-wave rectifier circuit for the level meter. Therefore, a DC voltage can be obtained by attaching time constants to the METER 1 and 2 output pins. The output voltage is set to 1.6V (+1.1dBv) during reference input. (for an external time constant of 56k $\Omega$ , 33 $\mu\text{F}$ )

The MT C pin detects only the AC component. The low frequency cut-off is determined with the capacitor connected to this pin and the 14k $\Omega$  internal resistor. (Approximately 10Hz for 1 $\mu\text{F}$ )

**7. Recording volume control circuit**

The CXA1878Q adjusts the size of the recording signal with a built-in control circuit. Therefore, the gain can be controlled by applying the voltage between DVcc and DGND to the REC VOL pin (Pin 28).

(A 0dB signal is output when voltage of 2.0V is applied.)

**8. Recording volume balance circuit**

The CXA1878Q contains a circuit which controls the balance between channels 1 and 2 of the recording volume.

Therefore, the balance between channels 1 and 2 can be controlled by applying the voltage between DVCC and DGND to the REC BAL pin (Pin 29).

(Signals which are not attenuated by the balance circuit are output from both channels when this control pin is open or when a voltage of DVCC/2 is applied.)

REC VOL Control Voltage

Pin No.	Symbol	Pin voltage (V)					Remarks
		0.0	0.5	2.0	4.5	5.0	
28	REC VOL	Decrease <<<< Increase					VOLOUT1 and 2 attenuation (dB) BALANCE = 2.5V, f = 1kHz
		Less than -96	-96	0.0	—	9.0	

BALANC control voltage

Pin No.	Symbol	Pin voltage (V)					Remarks
		0.0	0.5	2.5	4.5	5.0	
29	REC BAL	Increase >>>> Decrease					VOLOUT2 attenuation (dB) REC VOL = 5V, f = 1kHz
		0.0	0.0	0.0	-93	Less than -93	
		Decrease <<<< Increase					VOLOUT1 attenuation (dB) REC VOL = 5V, f = 1kHz
		Less than -93	-93	0.0	0.0	0.0	

**9. Bias OSC power supply control circuit**

The CXA1878Q contains a switch circuit that selects the supply voltage for the bias oscillator.

The supply voltage can be controlled with the B EQ pin (Pin 24). The maximum output current is 2mA.

10. AMS circuit

The CXA1878Q has the music sensor circuit.

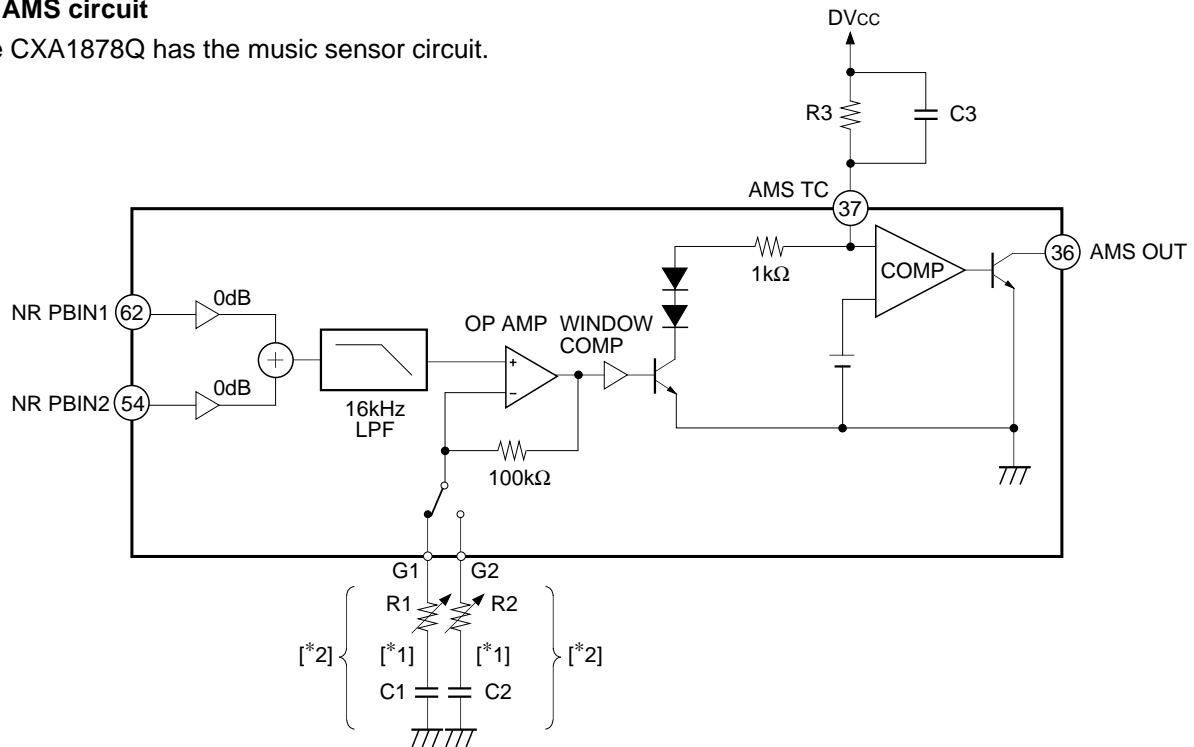

Fig. 4. AMS circuit block diagram

(1) AMS ON operation

The signal input from PB NR IN first passes through the LPF, then through the HPF/sensitivity setting amplifier, and then through the WINDOW comparator where it is formed into a pulse wave. (See Fig. 5)  
 This signal which has been formed into a pulse wave is integrated by a capacitor connected to the AMS TC pin (Pin 37) and then input to the comparator. (See Fig. 6)  
 AMS OUT turns ON when the AMS TC pin voltage falls below the comparator threshold value.  
 (When the sensitivity changes, the pulse width also changes.)

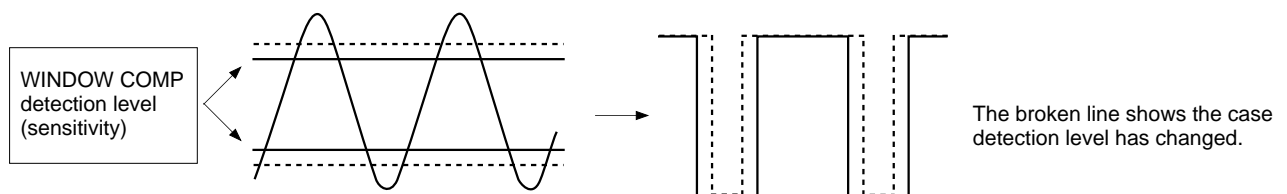

Fig. 5. Conceptual diagram of WINDOW comparator operation

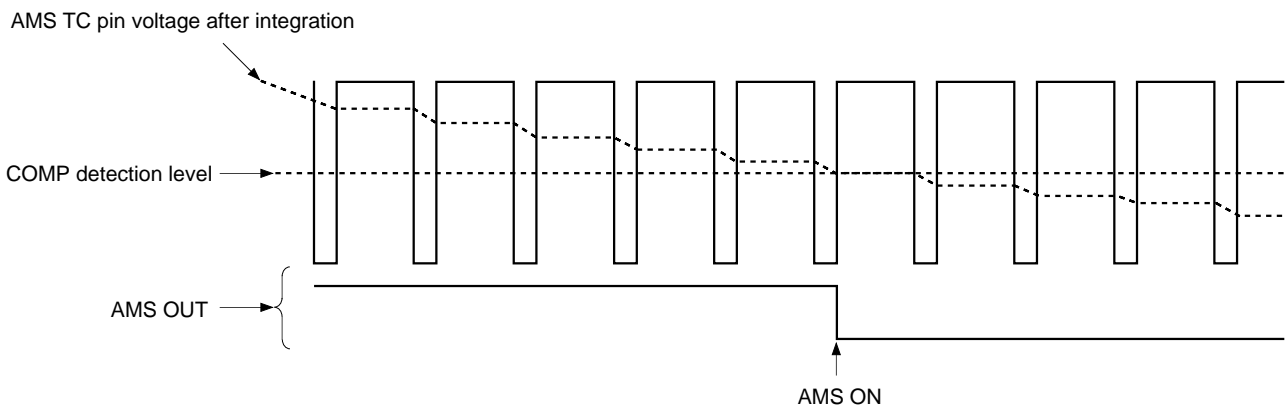

Fig. 6. Conceptual diagram of AMS OUT operation

## (2) AMS OFF operation

When the input signal disappears, the capacitance connected to the AMS TC pin (Pin 37) is discharged, causing the TC pin voltage to rise above the threshold value and turn AMS OFF.

## (3) AMS gain setting method

The AMS gain (G1/G2 mode gain) adjustment can be determined by external resistances R1 and R2. In addition, AMS gain is expressed by the following equations.

$$G1 = 20 \log \frac{R1 + 100k\Omega \text{ (internal resistance)}}{R1} \text{ dB}$$

$$G2 = 20 \log \frac{R2 + 100k\Omega \text{ (internal resistance)}}{R2} \text{ dB}$$

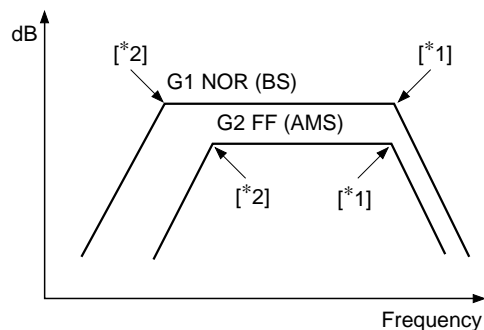

## (4) AMS low frequency cut-off setting method

The AMS low frequency cut-off adjustment can be determined by external resistances R1 and R2 and capacitances C1 and C2.

## (5) Relationship between response time and sensitivity

The AMS ON time is determined by the width of the pulse obtained by applying the input signal to the WINDOW comparator. The pulse emitted from the WINDOW comparator becomes extremely small near the detection level, and some time is required for this pulse to be integrated by the external capacitance, thus lengthening the response time.

\* Response times can be adjusted to approximately the same value by adjusting the AMS sensitivity with resistances R1 and R2 to match the various ICs. Also, the AMS OFF time is determined by the external time constant (R3, C3).

**Notes on Operation**

## Temperature characteristics and accuracy of the recording equalizer amplifier

The temperature characteristics of the built-in monolithic filter and the filter cut-off frequency depend on the 27k $\Omega$  external resistance connected to the IREF pin (Pin 10). Also, the recording equalizer amplifier frequency response depends on unevenness in the absolute, as well as relative values of the internal capacitance. Furthermore, the high frequency response indicates a high element sensitivity at the filter because the band-pass filter Q is high. Compared to low frequency, although the unevenness inherent in the IC is more likely to occur, this occurs relatively, and not individually for channels 1 and 2.

Example of Representative Characteristics

Recording equalizer amplifier frequency response (NORMAL SPEED)

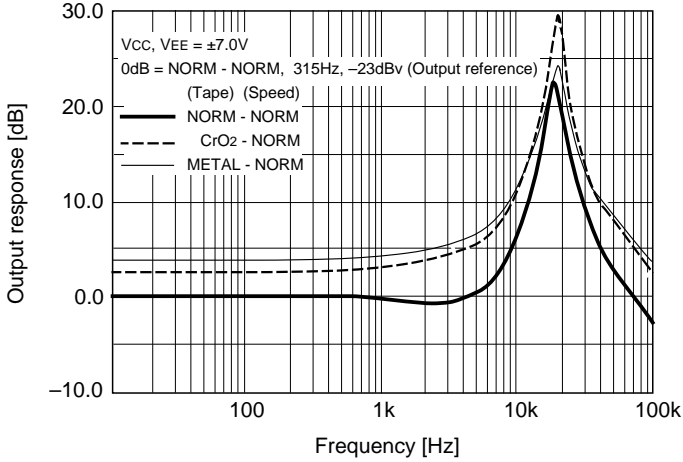

Recording equalizer amplifier frequency response (HIGH SPEED)

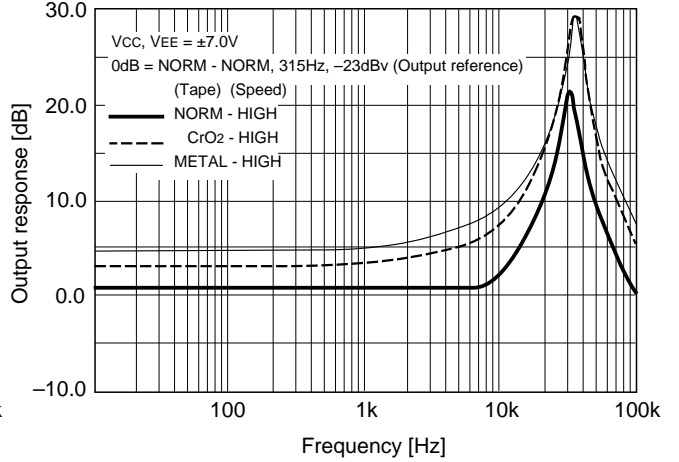

Output level vs. REC CAL pin voltage

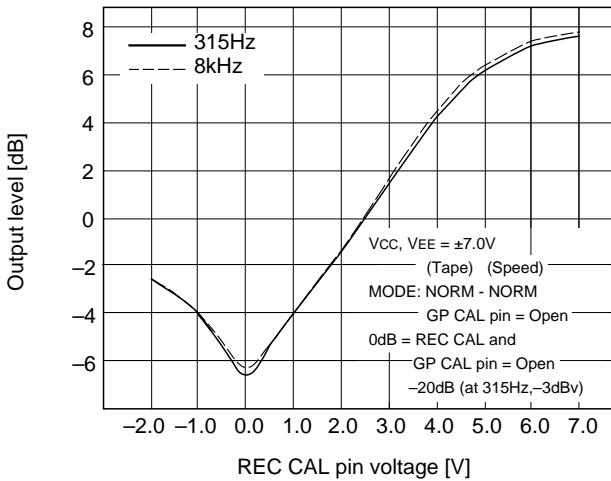

Output level vs. GP CAL pin voltage

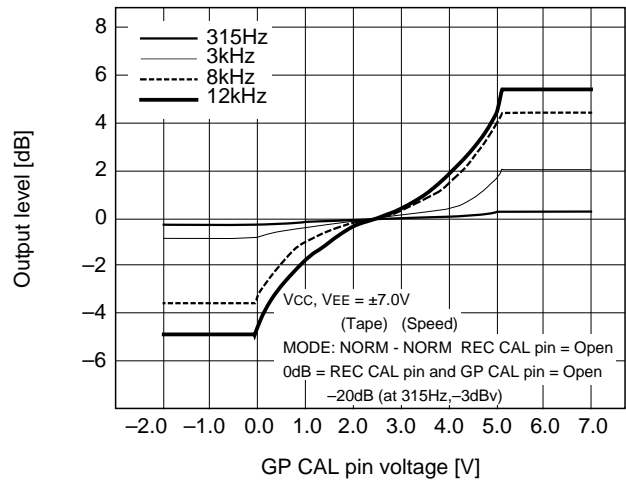

REC CAL and GP CAL frequency response

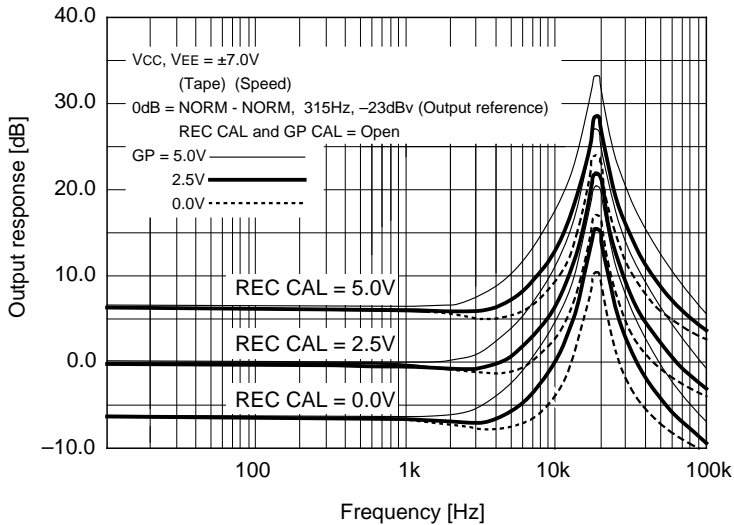

Output level vs. REC MUTE pin voltage 1

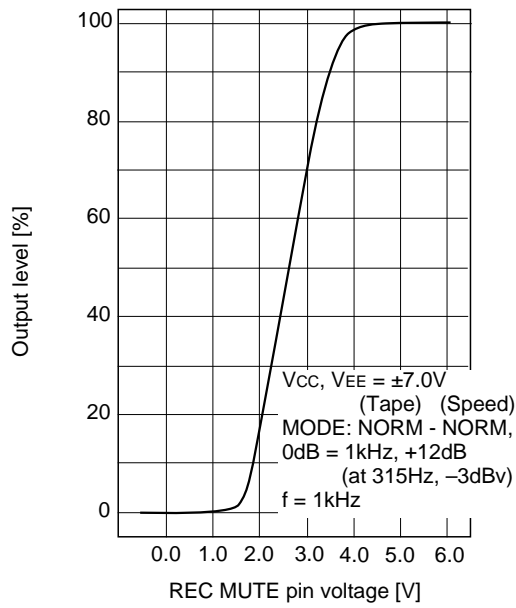

Output level vs. REC MUTE pin voltage 2

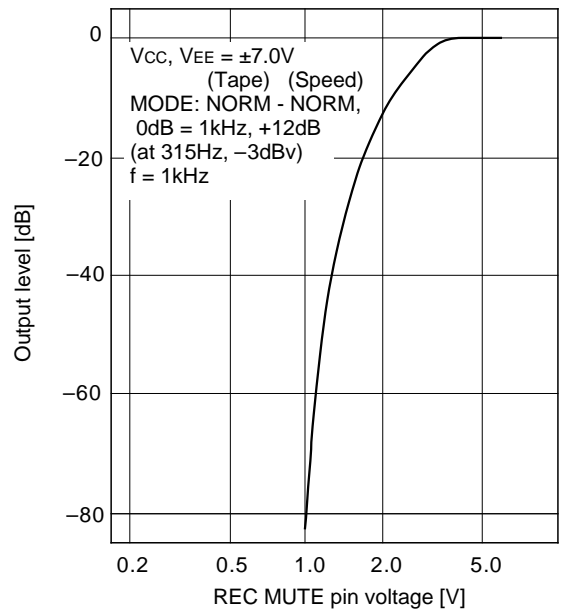

Output level vs. REC MUTE pin voltage 3

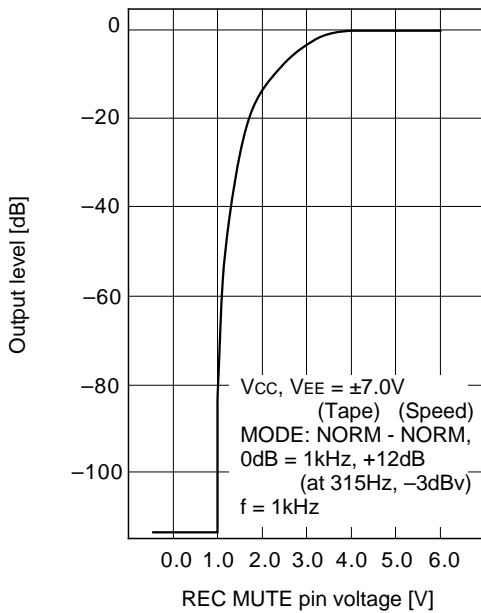

Recording equalizer amplifier load characteristics

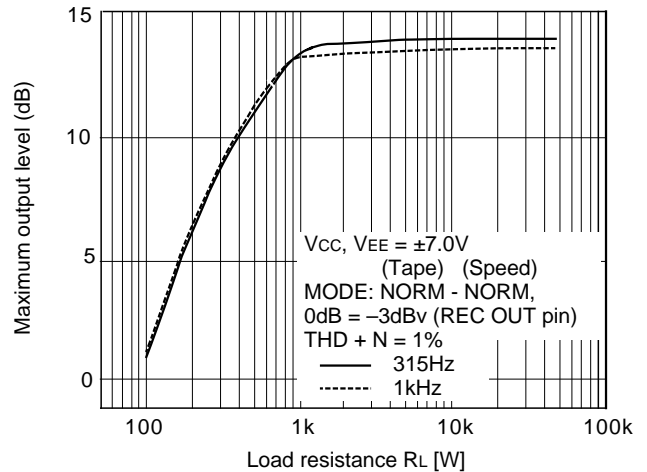

Recording volume characteristics

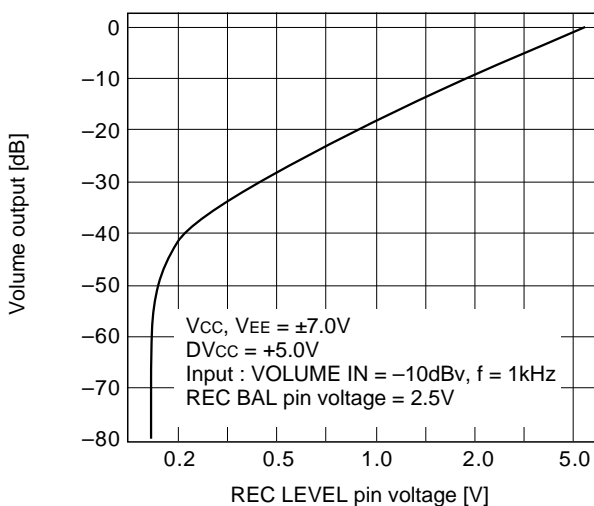

Recording volume balance characteristics

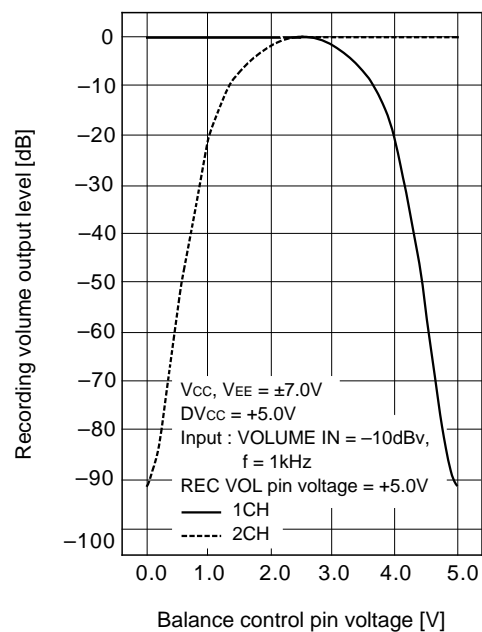



Level meter output characteristics (REC, PB mode)

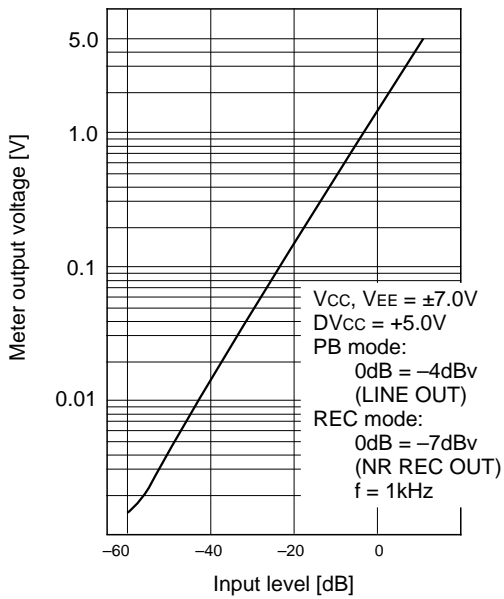

Meter rectification output characteristics

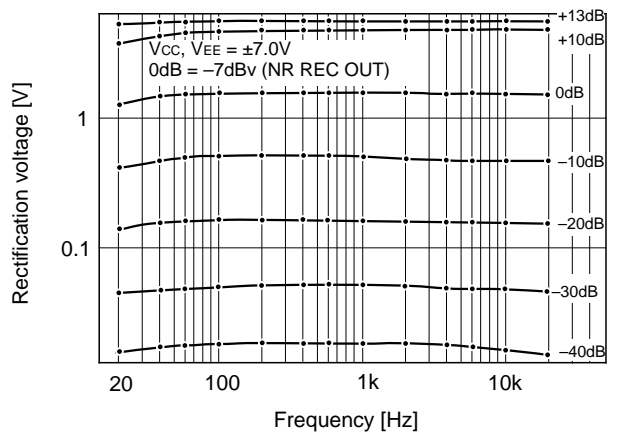

Playback equalizer amplifier distortion

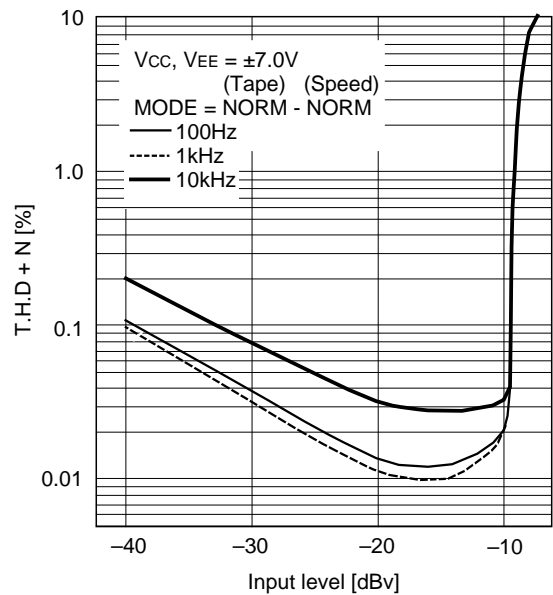

Playback equalizer amplifier frequency response

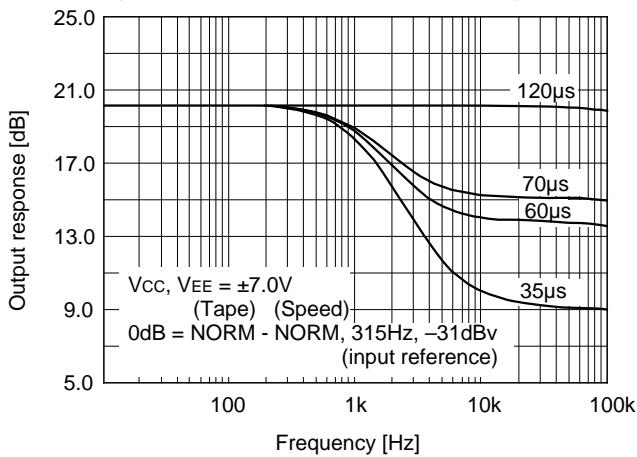

Line amplifier THD + N

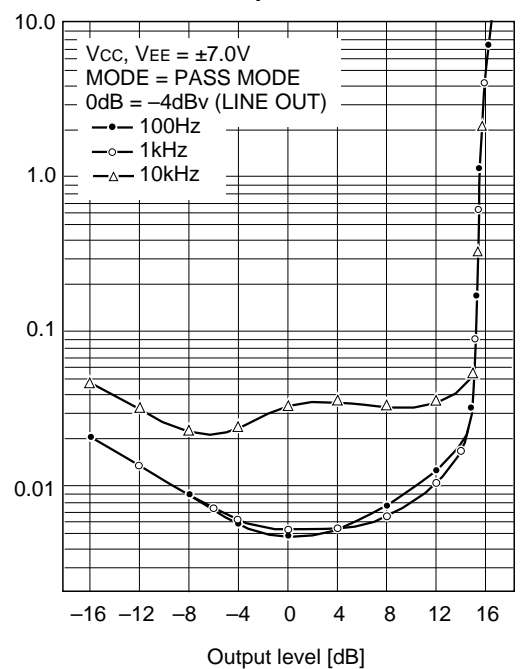

Line amplifier frequency response (PASS mode)

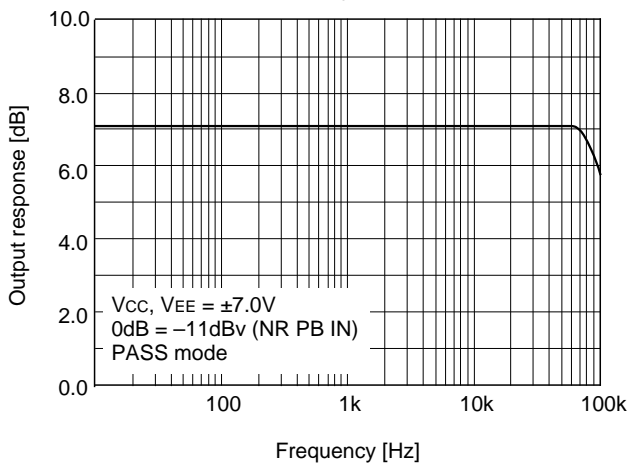

**A.M./S/B.S mode frequency response**

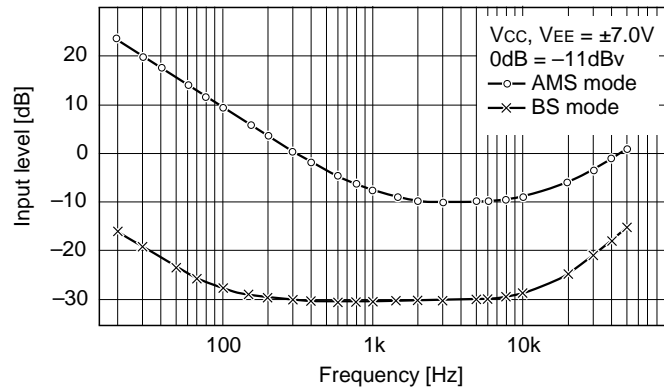

**BIAS SW load characteristics**

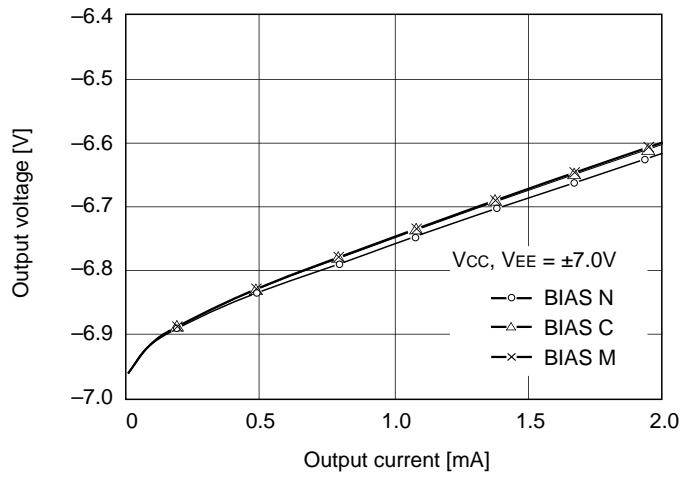

**Supply voltage vs. Current consumption**

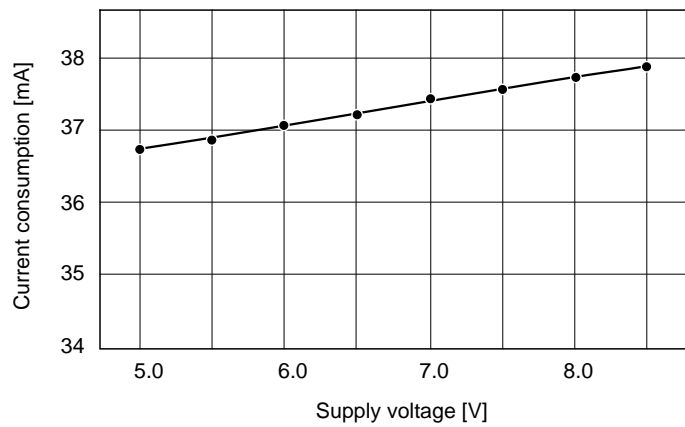

**Dolby B type NR encode boost**

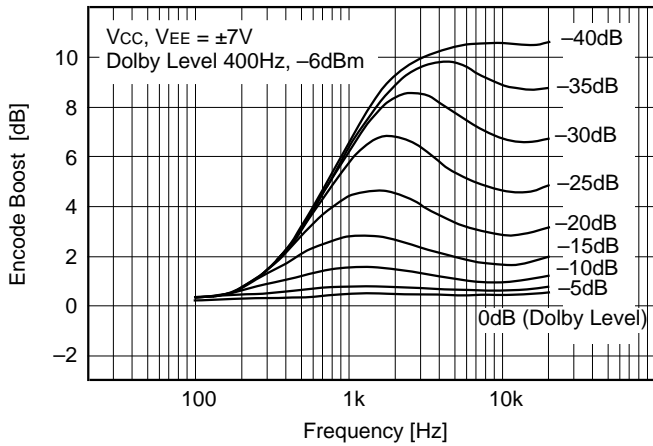

**Dolby C type NR encode boost**

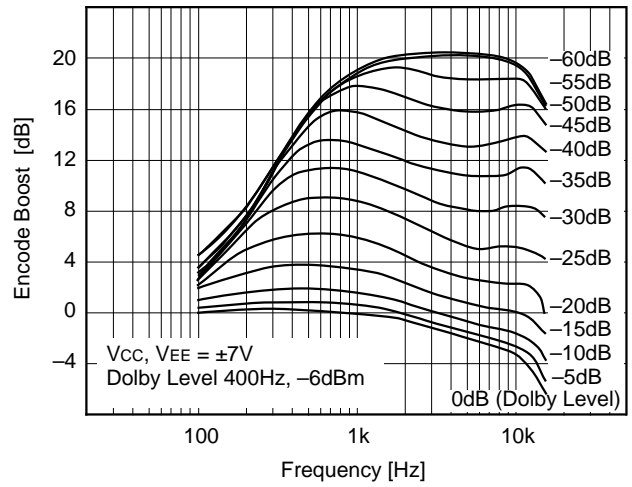

**Dolby NR OFF total harmonic distortion**

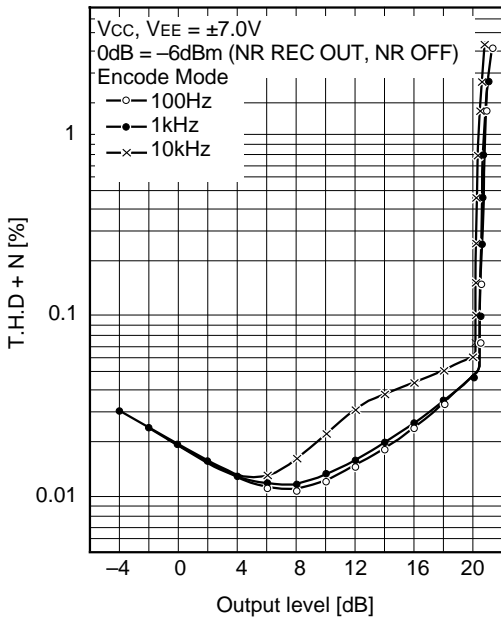

**Dolby B type NR total harmonic distortion**

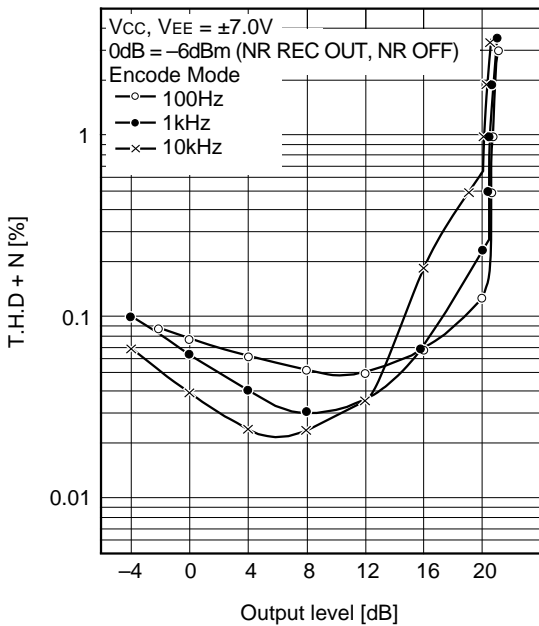

**Dolby C type NR total harmonic distortion**

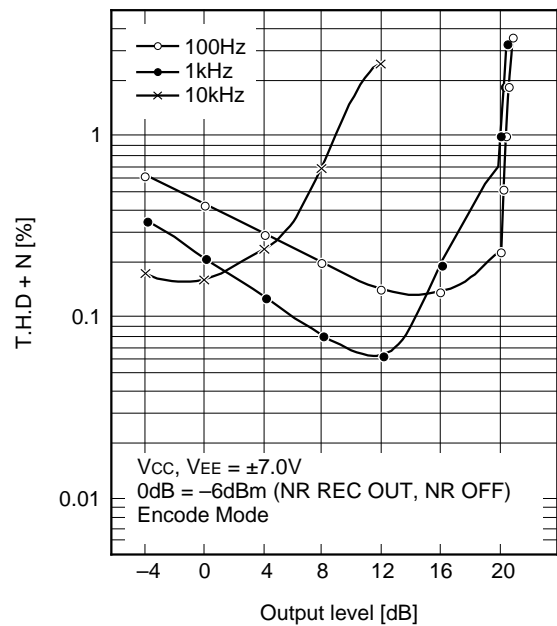

Package Outline

Unit: mm

64PIN QFP(PLASTIC)

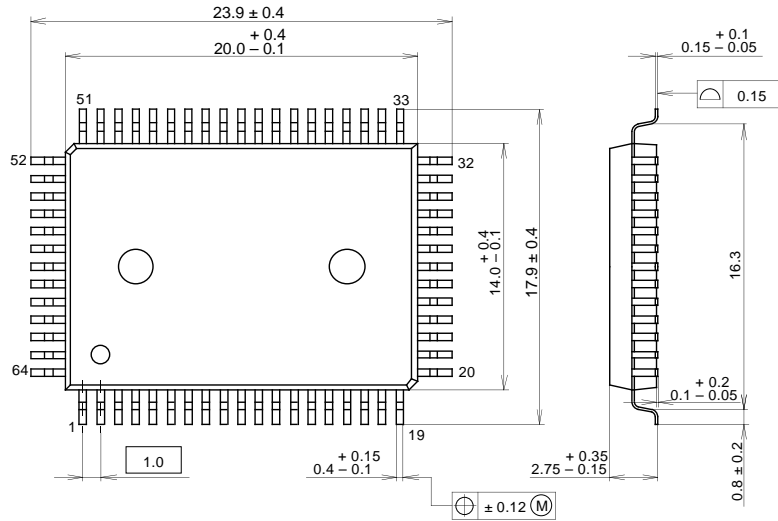

PACKAGE STRUCTURE

SONY CODE	QFP-64P-L01
EIAJ CODE	QFP064-P-1420
JEDEC CODE	_____

PACKAGE MATERIAL	EPOXY RESIN
LEAD TREATMENT	SOLDER/PALLADIUM PLATING
LEAD MATERIAL	42/COPPER ALLOY
PACKAGE MASS	1.5g